

EMC Filter

FEATURES

- Compact size, high isolation
- Efficiency up to 97%
- Ensure the power supply module to meet the requirement of IEC/EN61000-4 and CISPR22/EN55022
- Cost-effective



RoHS

This model applies to analog circuit which is noise-sensitive. Put FC-A01D & FC-B01D on to the input of DC/DC module can ensure the module meet Surge level of IEC/EN61000-4-5 ±2KV (2Ω internal resistance)/±4KV (12Ω internal resistance) and EMI requirement of CISPR22 /EN 55022 Class B.

EMC filter used with the MORNSUN DC/DC module, DC/DC module's max. Input voltage must less than EMC filter's max. Voltage, DC/DC module's max. Input current must less than EMC filter's nominal current.

Selection Guide

Model	Input Voltage Range (VAC)	Nominal Current (A)(max)
FC-A01D	9-36	1
FC-B01D	18-75	1

Note: series with suffix "A2S" are chassis mounting, with suffix "A4S" are DIN-Rail mounting, for example FC-A01DA4S.

General Specifications

Item	Test Conditions	Min.	Typ.	Max.	Unit
Efficiency	24VDC @1A	-	97	-	%
Operating Temperature		-40	-	85	°C
Storage Temperature		-55	-	105	
Casing Temperature Rise	24VDC @1A	-	15	-	
Test Voltage (L/PE, N/PE)	Tested for 1 minute and leakage current: 5 mA	-	1.5	-	KVAC

General Specifications

Casing Material	Black flame-retardant heat-proof epoxy resin (UL94-V0)	
Package Dimensions	Horizontal package	37.00*23.00*15.00 mm
	A2S wiring package	76.00*31.50*23.80 mm
	A4S rail package	76.00*31.50*28.40 mm
Weight	Horizontal package/A2S wiring package/A4S rail package 20g/40g/60g(Typ.)	

SAFE & EMC

Item	Test Conditions		Test Procedure
EMI	Conducted disturbance	150KHz-30MHz Class B (With MORNSUN's Module)	CISPR22,EN55022
	Radiated emission	30MHz-1GHz Class B (With MORNSUN's Module)	CISPR22,EN55022
EMS	Electrostatic discharge	Air ±8KV Contact ±6KV	perf.Criteria B IEC/EN61000-4-2,GB/T17626.2
	Radiation immunity	10V/m (With MORNSUN's Module)	perf.Criteria A IEC/EN61000-4-3,GB/T17626.3
	Conducted disturbance immunity	10Vr.m.s (With MORNSUN's Module)	perf.Criteria A IEC/EN61000-4-6,GB/T17626.6
	EFT	±4KV (5KHz,100KHz)	perf. Criteria B IEC/EN61000-4-4,GB/T17626.4
	Surge immunity	±2KV(1.2µs/50µs 2Ω) ±4KV(1.2µs/50µs 12Ω)	perf. Criteria B IEC/EN61000-4-5,GB/T17626.5

EMC Specifications

① FC-A01D Surge Test Result

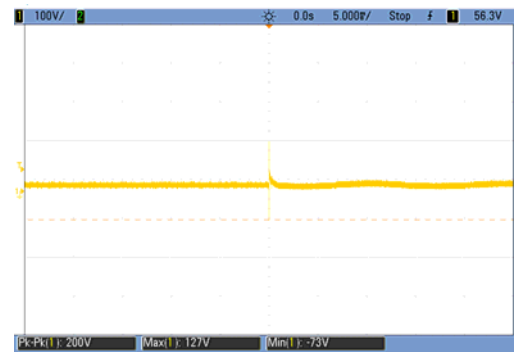

Note: The above test results are supporting VRB2405D-10WR2 measured at full load.

② FC-B01D Surge Test Result

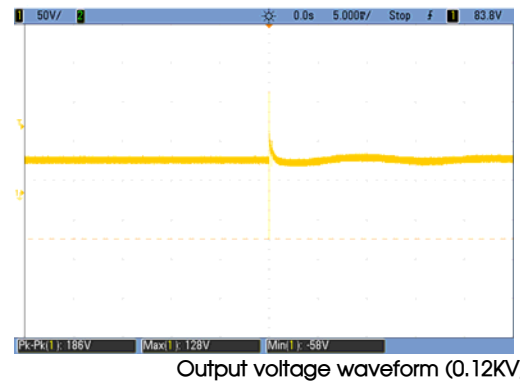
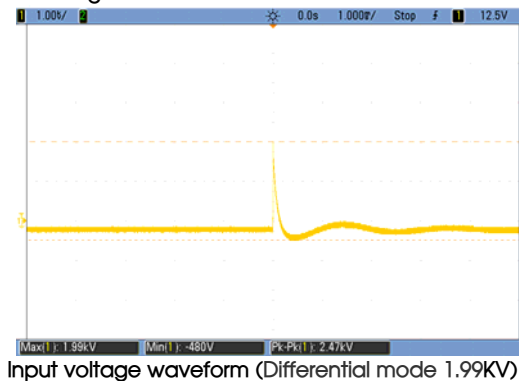

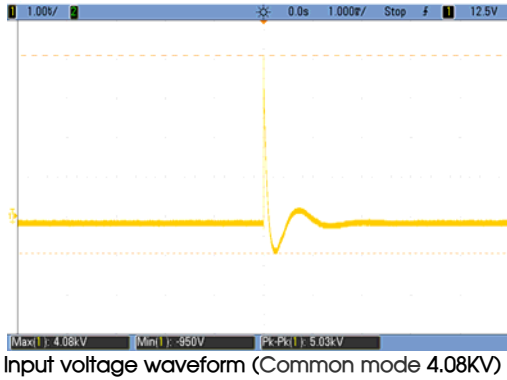

Note: The above test results are supporting VRB4805D-10WR2 measured at full load.

Product Characteristic Curve

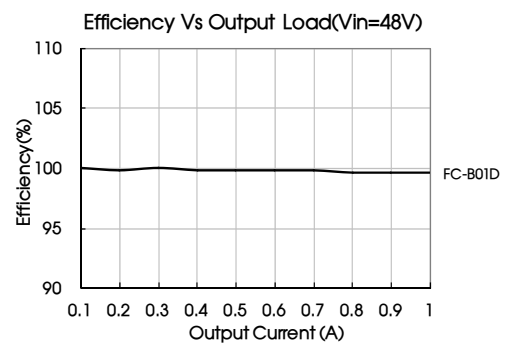
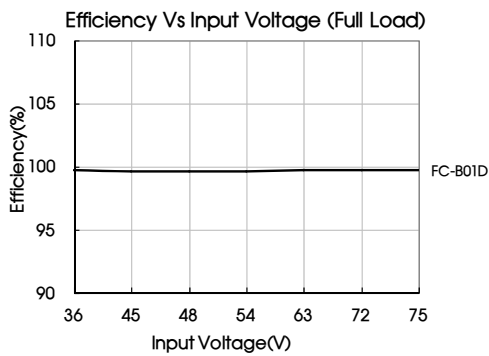
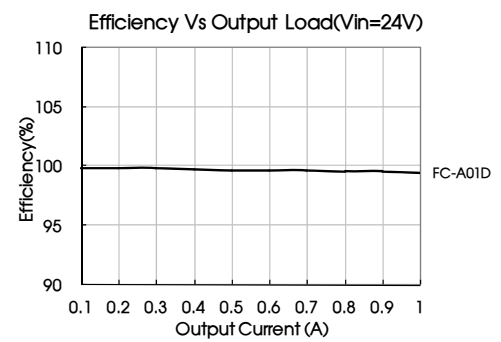
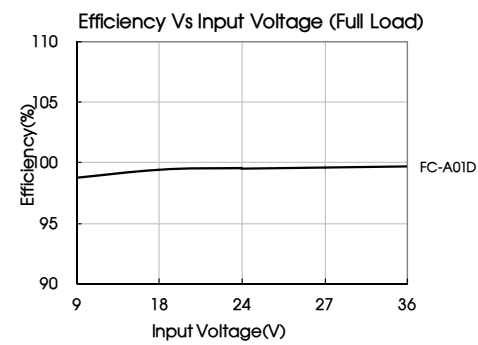

Design Reference

1. Inside schematic

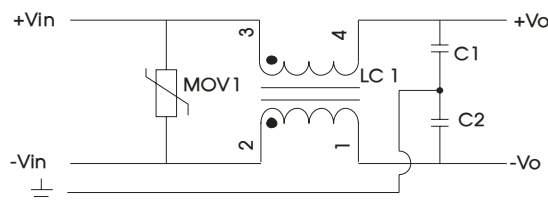

2. Typical application

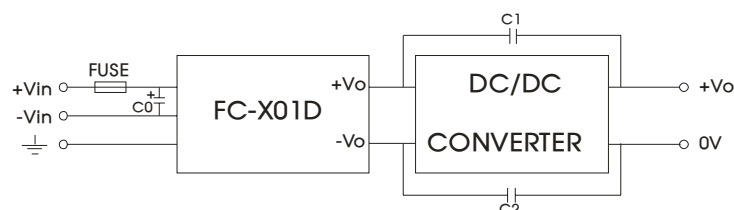

Model	Recommended external circuit parameters
C0	Recommend to use 330uF/100V electrolytic capacitor
C1, C2	1000pF/400VAC capacitor
FUSE	Due to the difference of the power module input current, the fuse of the recommended values, please refer to the Technical Manual for the power module.

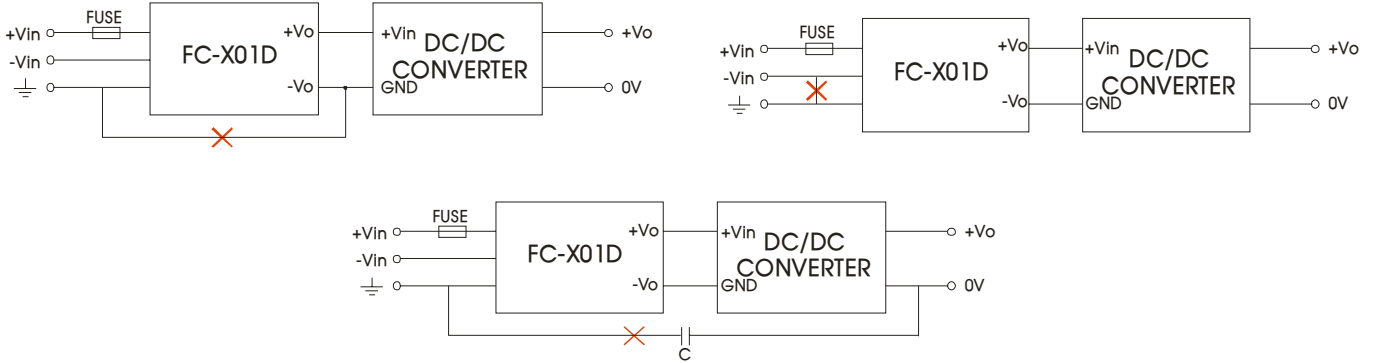

Note: These applications is not supported for this model.

3. For more information please find the application notes on www.mornsun-power.com

FC-A01D & FC-B01D Dimensions and Recommended Layout

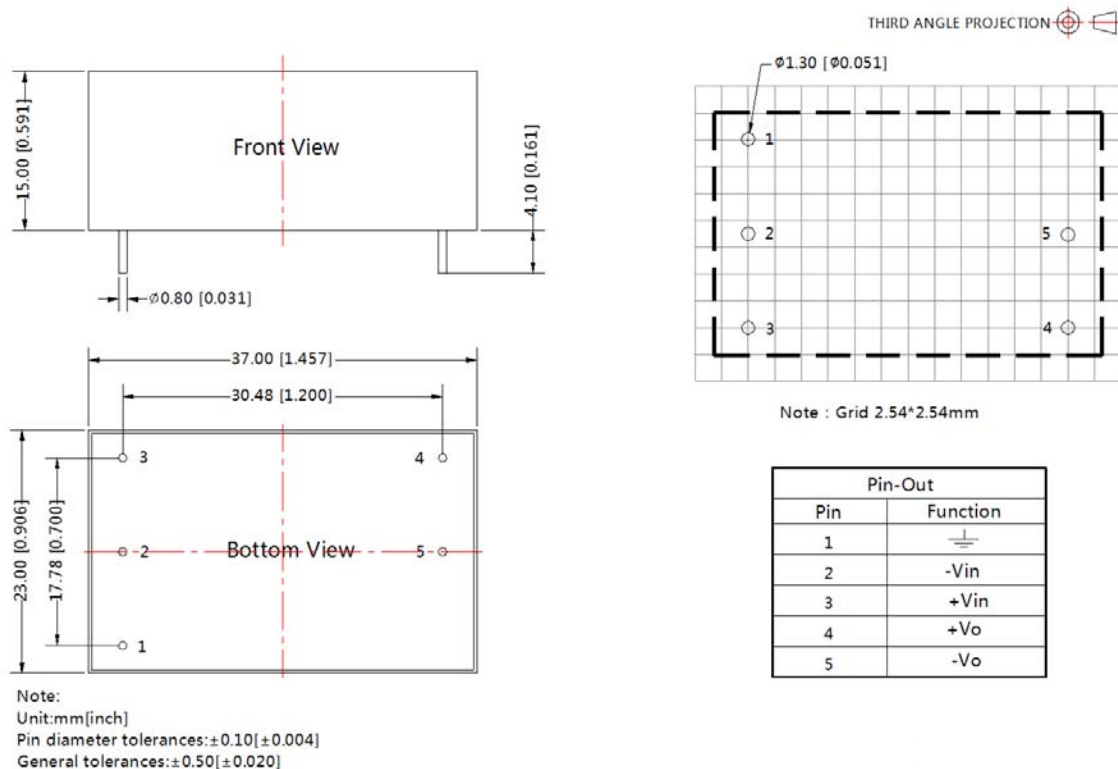

FC-A01DA2S & FC-B01DA2S Dimensions

THIRD ANGLE PROJECTION

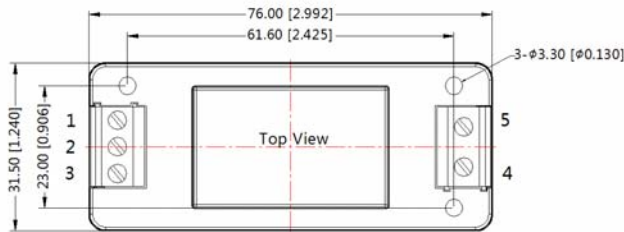

Pin-Out	
Pin	Function
1	⊥
2	-Vin
3	+Vin
4	+Vo
5	-Vo

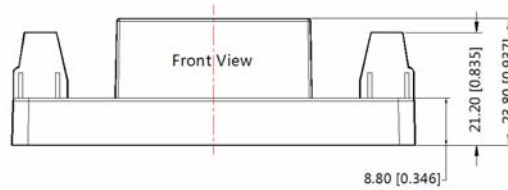

Note:
Unit :mm[inch]
Pin diameter tolerances :±0.10[±0.004]
General tolerances:±0.50[±0.020]

FC-A01DA4S & FC-B01DA4S Dimensions

THIRD ANGLE PROJECTION

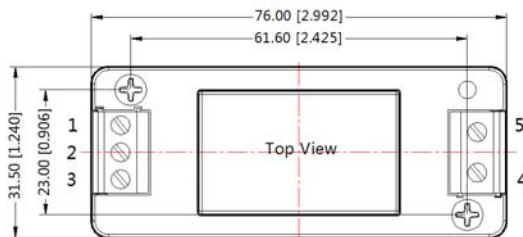

Pin-Out	
Pin	Function
1	⊥
2	-Vin
3	+Vin
4	+Vo
5	-Vo

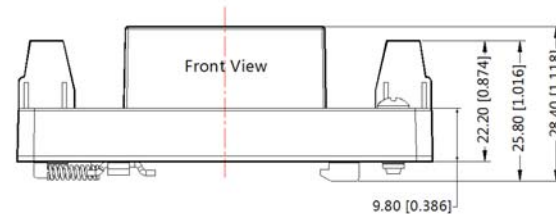

Note:
Unit :mm[inch]
Pin diameter tolerances :±0.10[±0.004]
General tolerances:±0.50[±0.020]

- Note:
1. Packing Information please refer to 'Product Packing Information'. The Packing bag number of Horizontal package : 58220001, the Packing bag number of A2S/ A4S package:58220022;
 2. Unless otherwise specified, data in this data sheet should be tested under the conditions of Ta=25°C, humidity<75%;
 3. All index testing methods in this datasheet are based on our Company's corporate standards;
 4. The performance indexes of the product models listed in this manual are as above, but some indexes of non-standard model products will exceed the above-mentioned requirements, and please directly contact our technicians for specific information;
 5. We can provide product customization service;
 6. Specifications of this product are subject to changes without prior notice.

MORNSUN Guangzhou Science & Technology Co., Ltd.

Address: No. 5, Kehui St. 1, Kehui Development Center, Science Ave., Guangzhou Science City, Luogang District, Guangzhou, P. R. China
Tel: 86-20-38601850-8801 Fax: 86-20-38601272 E-mail: info@mornsun.cn